

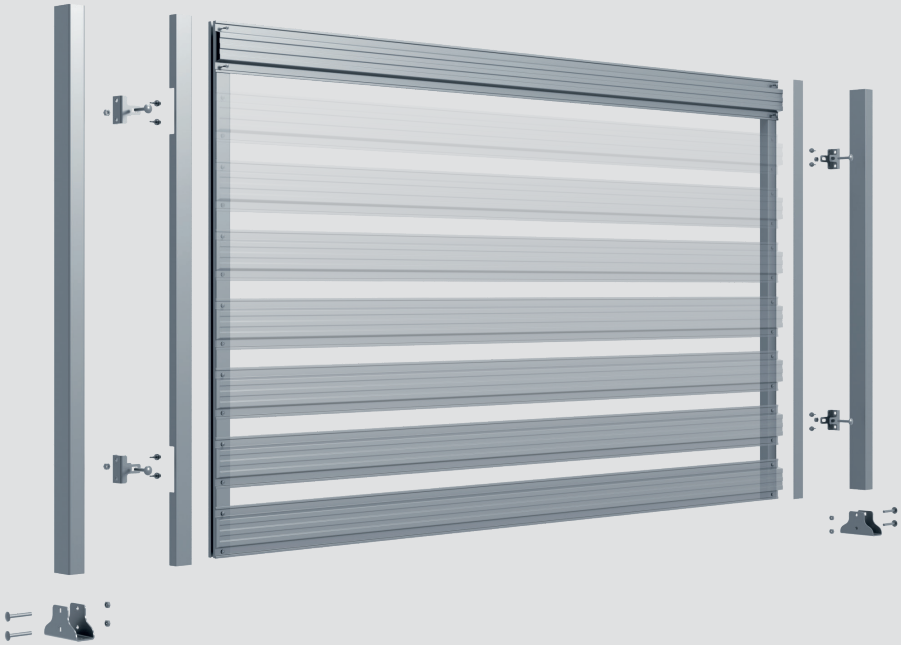

Budmat.

TVORŲ SISTEMOS FENCE SYSTEM



**HORIZONTALAUS SEGMENTO
MONTAVIMO INSTRUKCIJA**
INSTALLATION MANUAL FOR HORIZONTAL SPAN

PAKUOTĖS SU JŪSŲ TVORA TURINYS

PACK WITH YOUR FENCE

| | Prekių linija <small>Collections</small> | Variantai <small>Models</small> |
|--|--|---|
| | Sicuro Spazio Unico | SI-02 SP-02 UN-02 |
| Elementai <small>Elements</small> | Ilgis [mb] <small>Length [m]</small> | Kiekis [vnt.] <small>Length [m]</small> |
| P Plieninė dvipusio dažymo tvoralentė <small>Steel profile varnished on both sides</small> | 2 | 8 |
| Z Plieningis horizontalus profilis dažytas miltelinu būdu <small>Powder coated steel pole</small> | 1,2 | 2 |
| M Užbaigimo elementas <small>Cover</small> | 1,2 | 2 |
| Tvirtinimas MZ-H <small>MZ-H Bracket</small> | | 4 |
| Varžtas 4,2x13 horizontalaus profilio spalvos <small>Fastener 4,2x13 in the color of the profile</small> | | 35 |
| Savisriegis varžtas 4,2x20 horizontalaus profilio spalvos <small>Sheet metal fastener 4,2x20 in the color of the profile</small> | | 8 |
| Varžto M8x45 komplektas (varžtas, poveržlė, veržlė) <small>Screw M8x45 set (screw, washer, nut)</small> | | 4 |
| Horizontalaus profilio dangtelis <small>Pole cap</small> | | 2 |

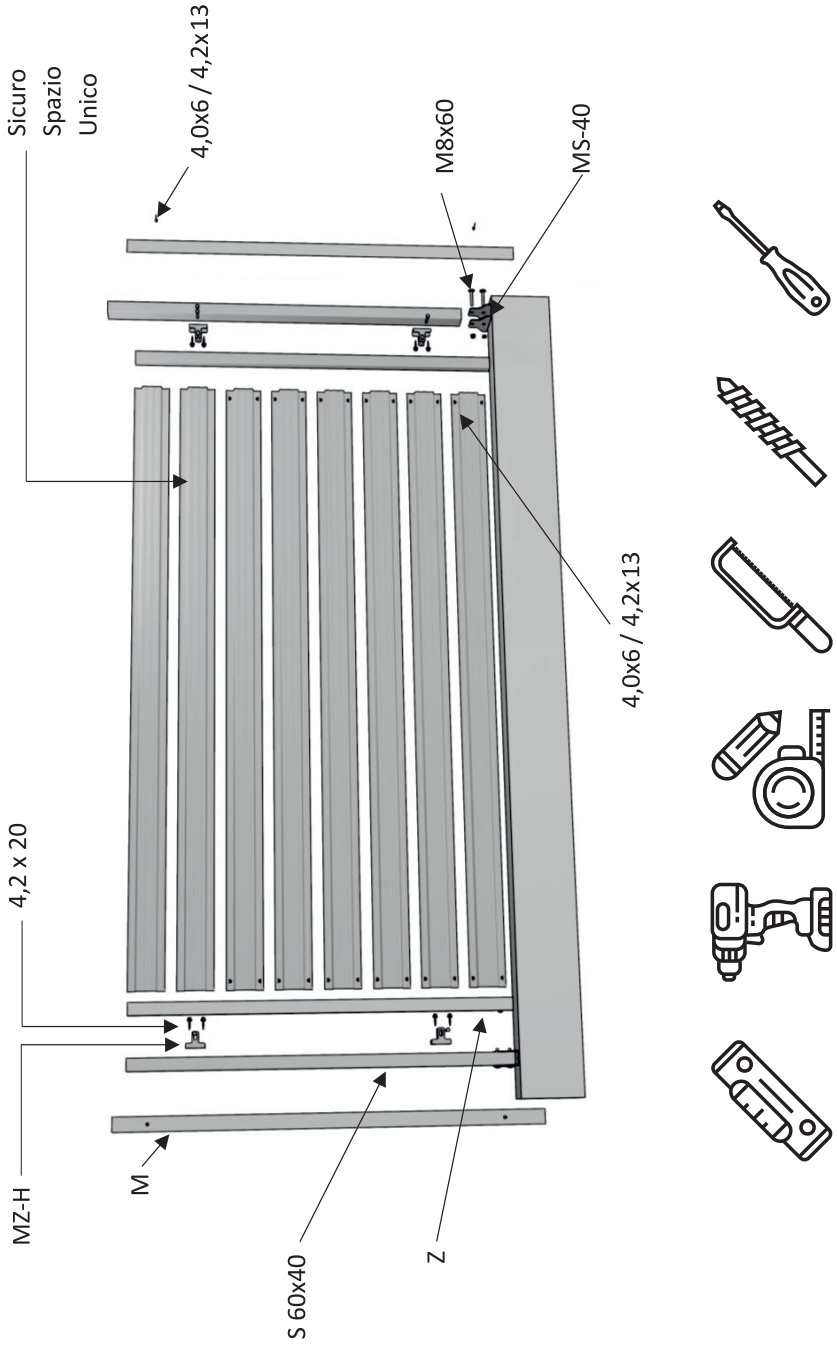

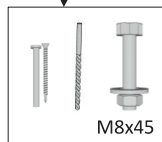
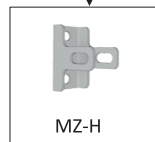
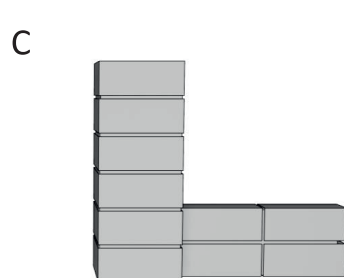
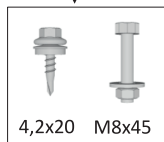
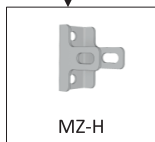
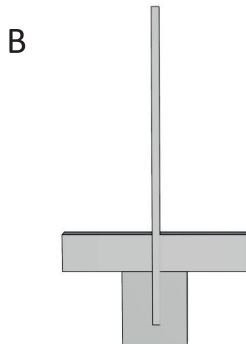
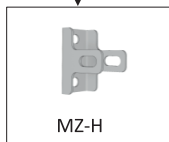
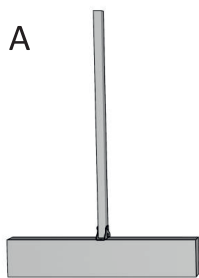

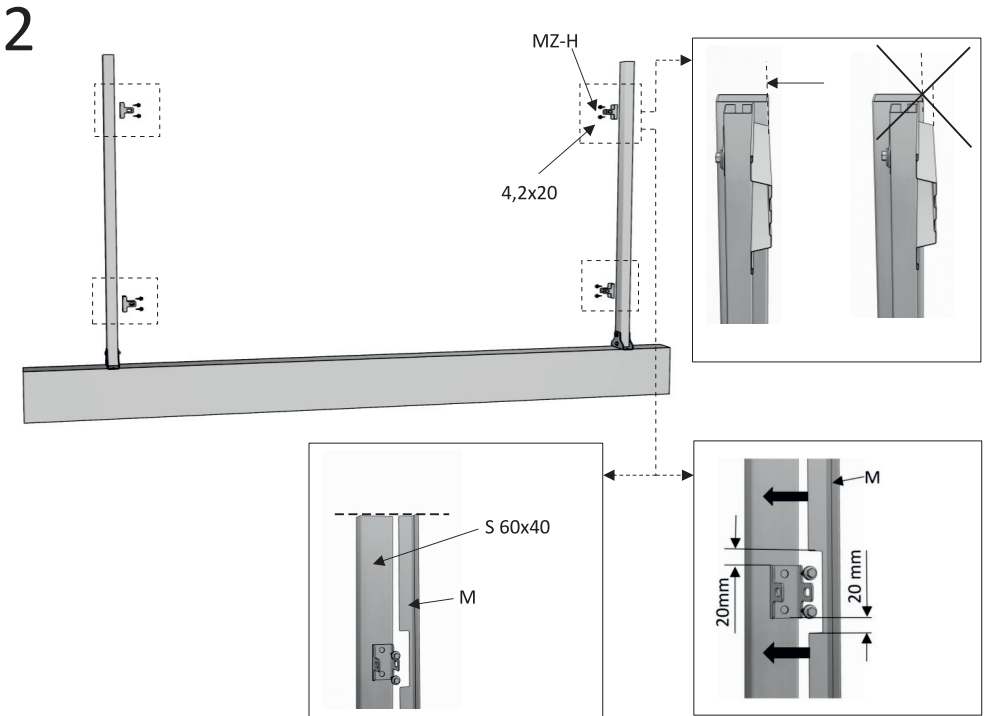
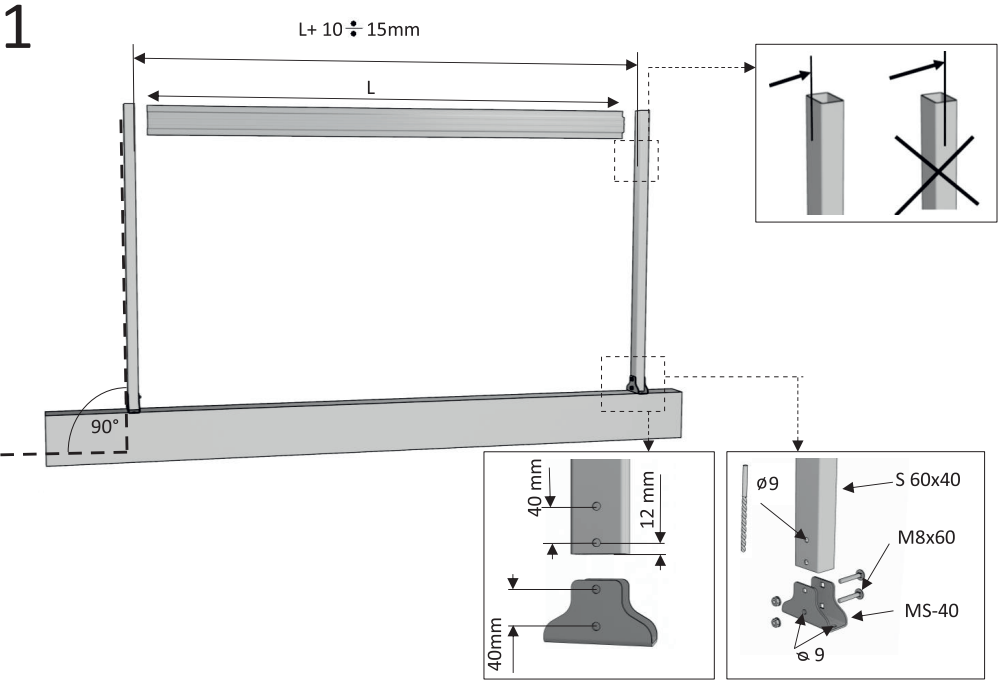

3

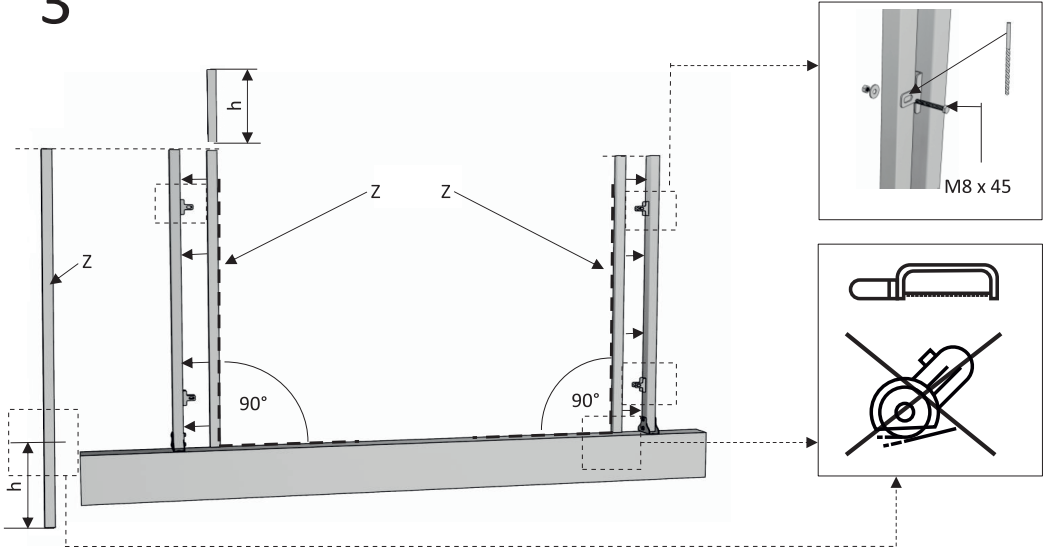

4

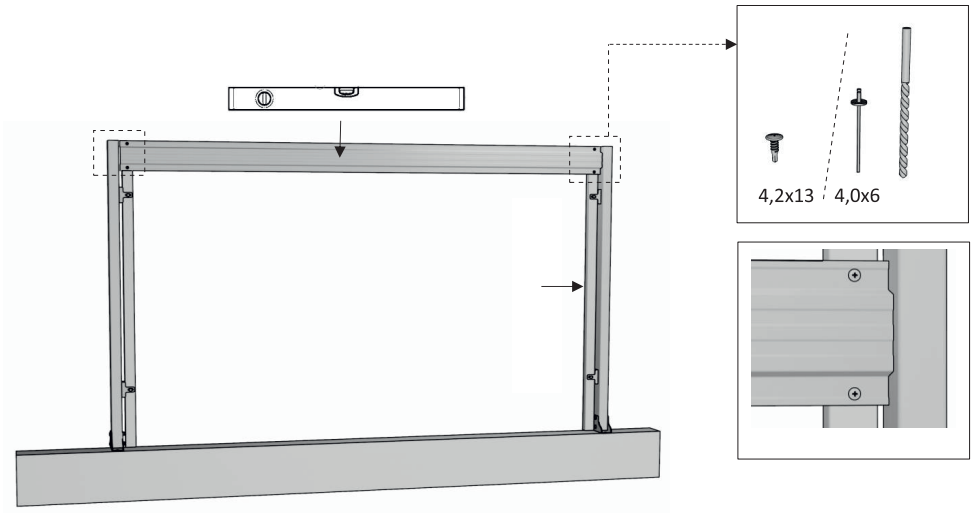

5

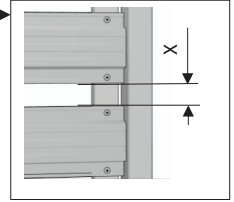
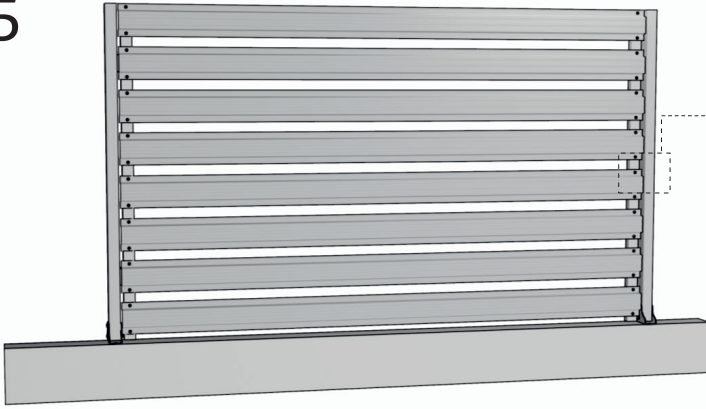

| | | 01 | 02 | 03 | 04 | 05 | 06 | 07 | 08 |
|--------|-----------|----|----|----|----|----|----|----|----|
| Sicuro | SI | 52 | 35 | 52 | 35 | 7 | 52 | 52 | 52 |
| Forte | FO | 49 | | 49 | | 40 | 49 | 49 | 49 |
| Spazio | SP | 52 | 35 | 52 | 35 | 7 | 52 | 52 | 52 |
| Unico | UN | 52 | 35 | 52 | 35 | 7 | 52 | 52 | 52 |

X_{UN-02} = 35 mm

| | | 01 | 02 | |
|--------|-----------|----|----|--|
| Sicuro | SI | 52 | 35 | |
| Forte | FO | 49 | | |
| Spazio | SP | 52 | 35 | |
| Unico | UN | 52 | 35 | |

6

